

H Heiden

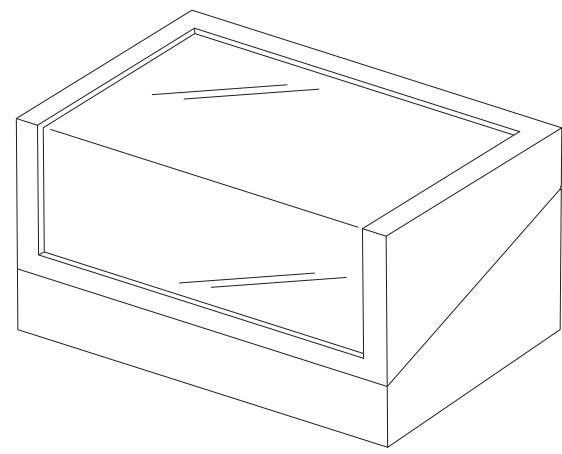

Instruction Manual

105mm

105mm

148.5mm

Back

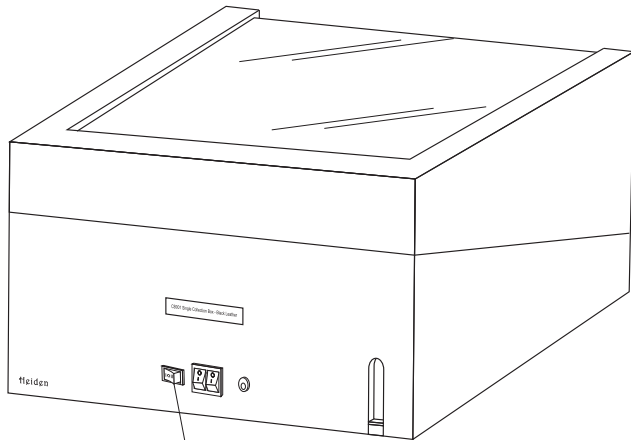

Power Switch

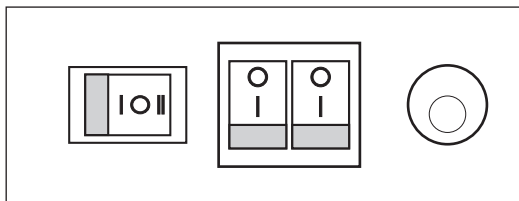

ADAPTOR PLUG IN (6V DC 100mA)
WITH UL VERSION AC

Power Switch and Direction Settings



CLOCKWISE

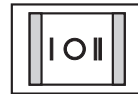

POWER OFF







COUNTER-
CLOCKWISE



WARNING:

- 1) Avoid exposing the watch winder to direct sun, water or other moisture, and extreme temperatures which may damage the box.
- 2) Turn off the power when not in use.

The watch winder has four modes to wind your watch.
 Please set the switches as follows to set a mode.
 Please note Mode 1,2 and 4 can be set to clockwise
 or counter-clockwise. Mode 3 is bi-directional.

Programmable Operating Instructions		TPD
Mode 1: The winding time is 60 seconds on, then 12 minutes off, then repeats until watch is wound.	 Mode 1	1460
Mode 2: The winding time is 60 seconds on, then 15 minutes off, then repeats until watch is wound.	 Mode 2	1178
Mode 3: The winding time is 60 seconds, then 18 minutes off, then 60 seconds in the opposite direction, then 18 minutes off, then repeats until watch is wound.	 Mode 3	988
Mode 4: The winding time is 60 seconds, then 24 minutes off, then repeats until watch is wound.	 Mode 4	746

NOTE: To change modes, turn off the power first. Then, once the mode is changed, turn the power back on.

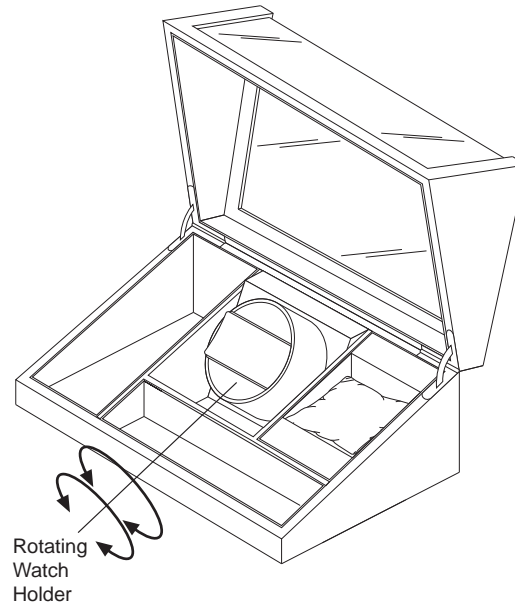

The C-watch holder can rotate a maximum weight of 1/3 pound - operated under a 6V transformer.

Automatic watch winding display
box instruction for
CB001

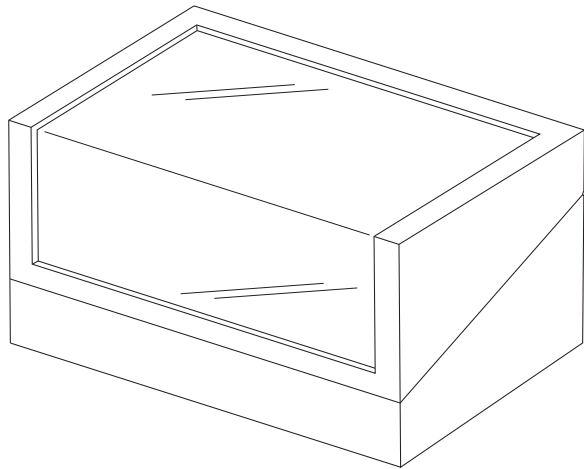

01

Back

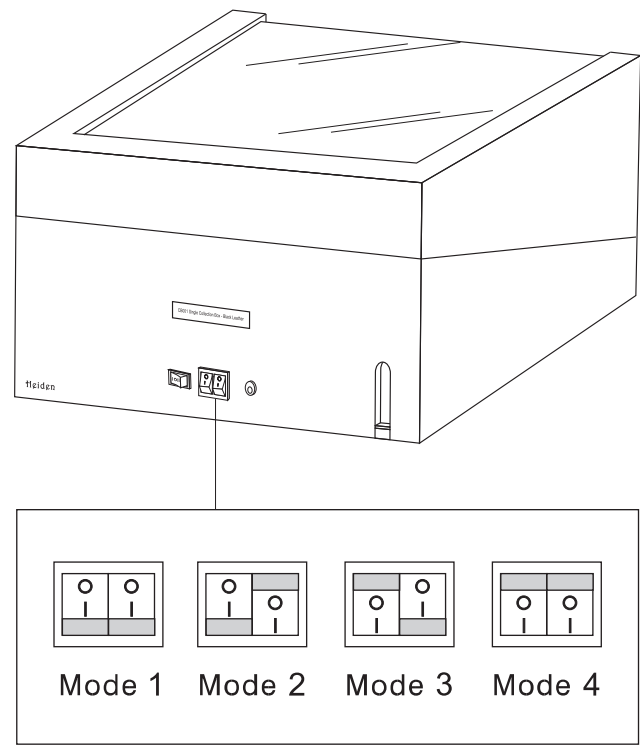

06